

## VISUAL INERTIA IN APPARENT MOTION

STUART ANSTIS

Department of Psychology, York University, 4700 Keele St., Downsview, Ontario, Canada M3J 1P3

and

V. S. RAMACHANDRAN

Department of Psychology, University of California at San Diego, La Jolla, CA 92093, U.S.A.

(Received 9 September 1985; in revised form 22 September 1986)

**Abstract**—Four dots in an imaginary diamond were flashed in succession to give ambiguous apparent motion (AM). The top and bottom dots were flashed at time  $t_1$  and replaced by the left and right dots at time  $t_2$ . If two priming dots were flashed beforehand at time  $t_0$  in line with two parallel sides of the diamond, AM was seen along those sides. We call this “visual inertia”. The amount of visual inertia (measured by a null method) fell off with increasing angle between the priming dot and the side of the diamond. Visual inertia was still seen when the priming dots were presented to one eye and the test dots to the other, so the effect must be partly central. The timing and length of the priming path made little difference to visual inertia. However, static priming dots were ineffective. We conclude that the visual system was examining at least *three* successive time frames in deciding which items in one frame correspond with which items in succeeding frames.

Movement perception    Apparent motion    Psychophysics    Correspondence problem

### INTRODUCTION

A dot which jumps back and forth between two positions at suitable temporal and spatial intervals will be seen in apparent motion (AM). Figure 1(a, b) show four dots forming an imaginary diamond. The north and south dots are flashed on at time 1 and are replaced by the east and west dots at time 2, and this cycle repeats continuously. The apparent motion produced by this display is ambiguous, since it is equally likely to occur in a northeast–southwest direction [Fig. 1(a)] as in a northwest–southeast direction [Fig. 1(b)]. We did not use dots arranged in a square with horizontal and vertical sides. Gengerelli (1948) noted that with this configuration subjects favoured vertical motion; probably because of a reluctance to see AM across the vertical midline of the retina.

We have used this four-dot stimulus to explore the factors which influence AM (Ramachandran and Anstis, 1983a). In particular we have described an effect which we called “visual inertia” (Ramachandran and Anstis, 1983b). If the quartet of dots was embedded in two straight parallel rows of dots which were flashed on in succession, there was a strong tendency to see AM in the direction of the embedding

motion. Rows of *static* dots had no such effect. Eggleston (1984) has also investigated similar phenomena. We have used the expression “priming dots” to refer to the dots flashed before or after the dots in the quartet and which potentially alter their AM, and the expression “test dots” to refer to the quartet of dots.

### EXPERIMENT 1

#### *Angular Function of Visual Inertia*

Ramachandran and Anstis (1983b) reported visual inertia when two rows of six priming dots were aligned with the sides of the diamond of test dots. In the present study we used a pair of priming dots presented just before the test dots [Fig. 1(c, d)] and found that this sufficed to produce visual inertia. Using a nulling staircase method, we measured visual inertia as a function of the *priming angle*  $A$ . The priming angle was designated zero when the two priming dots were above and below the diamond, in line with its vertical diagonal [Fig. 2(a)]. Under these conditions the display was symmetrical and the priming dots could therefore not favour either of the two possible AM paths. Visual inertia was thus not seen. However, when the priming dots

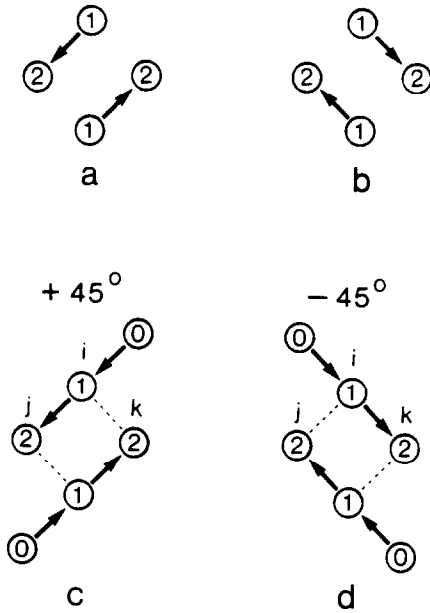

Fig. 1. Two dots were flashed up at the top and bottom corners of an imaginary diamond, then replaced by two dots at the left and right corners. This ambiguous stimulus gave apparent motion (AM), which could look either as in (a) or as in (b), in which solid arrows show direction of perceived apparent motion. Numbers inside spots indicate time of presentation; actual spots were tiny luminous dots. (c, d) When these dots were preceded by two priming dots at time  $t_0$ , the AM was seen along the axes of the priming dots (solid arrows). We call this effect "visual inertia". Priming angle  $A = +45^\circ$  in (c),  $-45^\circ$  in (d).  $i$  = priming path;  $j$ ,  $k$  are alternative paths the AM could take. Inertia was measured by altering the separation  $j$ , increasing it in condition (c) and reducing it in condition (d), until AM in both directions was equiprobable. Thus proximity, which favours AM, was titrated against visual inertia.

were aligned with the upper left and lower right sides of the diamond ( $A = +45^\circ$ ), they strongly favoured motion along these two sides [Fig. 1(c)]. Similarly, when the dots were aligned with the lower left and upper right sides of the diamond ( $A = -45^\circ$ ) they strongly favoured AM along these two sides [Fig. 1(d)]. We measured visual inertia over a range of priming angles  $A$  from  $-112.5$  to  $+112.5^\circ$  in steps of  $22.5^\circ$ .

We also varied the shape of the diamond. The "medium" diamond was square with its sides making an angle of  $\pm 45^\circ$  to the vertical. The "narrow" diamond was a tall rhombus with sides at an angle of  $\pm 22.5^\circ$  to the vertical. The "wide" diamond was a squat rhombus with sides at an angle of  $\pm 67.5^\circ$  to the vertical. The height:width aspect ratios of the diamonds were 1:1, 2.4:1 and 1:2.4 respectively. (The wide diamond was simply the narrow diamond laid on its side: both had corner angles of  $45$  and  $135^\circ$ .) The sides of all diamonds were 1.5 deg of visual angle in length. Thus 33 conditions were explored: eleven priming angles  $\times$  three diamond shapes. Figure 2 illustrates examples of three conditions. The number inside each dot shows the time at which it was presented, thus the priming dots were flashed at time  $t_0$  and the dots in the quartet at times  $t_1$  and  $t_2$ . The solid arrows show the AM path which was reinforced by the priming dots. In Fig. 2(a) the diamond was medium and the priming angle was  $0^\circ$  (vertical), not favouring AM in either direction. Figure 2(b) shows a narrow diamond and a priming angle of  $+90^\circ$ , so the priming dots

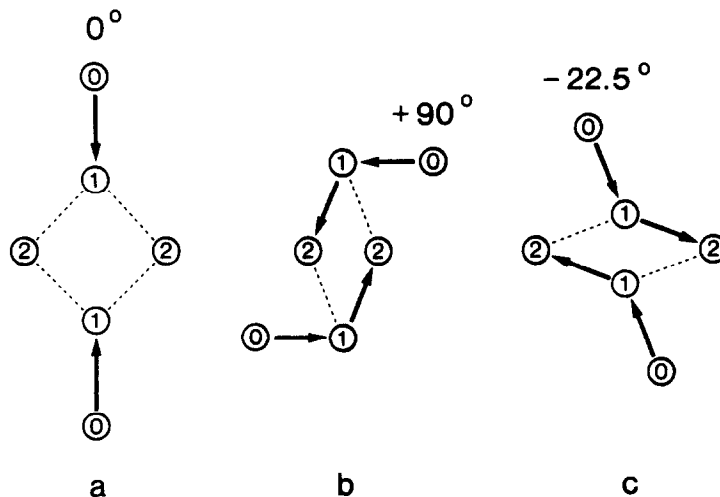

Fig. 2. Examples of the stimuli used in Experiment 1. Solid arrows show direction of AM which was promoted by the priming dots. (a) Medium (square) diamond. Priming angle  $A = 0^\circ$ . (b) Narrow diamond. Priming angle =  $+90^\circ$ . (c) Wide diamond. Priming angle =  $-22.5^\circ$ .

moved along horizontal trajectories from upper right and lower left, while Fig. 2(c) shows a wide diamond and a priming angle of  $-22.5^\circ$ .

The strength of visual inertia was measured by a nulling method. It is well known that proximity favours AM; when a dot at time  $t_1$  is replaced at time  $t_2$  by a nearby dot and a distant dot, AM is more likely to be seen toward the nearer dot (Ullman, 1979; Mather and Anstis, 1987). Using a method we have described elsewhere (Ramachandran and Anstis, 1983b) we used proximity to oppose, or back off, the inertia. In Fig. 1(c), visual inertia produced by the priming path *i* favoured AM along the left hand path *j*, so we increased the distance *j*, keeping the distance *k* constant, until both AMs were equally probable. In Fig. 1(d), visual inertia favoured AM along the right hand path *k*, so we shortened *j*, keeping *k* constant, until once again both AMs were equally probable. The ratio of *j* to *k* gave a measure of the strength of visual inertia. These operations changed the square diamond into a rectangle and the rhombic diamonds into parallelograms, but did not alter the angles at the corners of the diamonds.

#### Method

Five subjects were run, the first author (S.M.A.) and four practised subjects who were naive as to the intent of the experiment. The subject viewed a 12-in. t.v. monitor screen from a distance of 57 cm. The display was controlled by a microcomputer. A diamond shape (narrow, square or wide) was preselected for each run and then the eleven priming angles were presented in a random order selected by the computer. The priming path *i* and the sides *j*, *k* of each diamond of dots initially subtended 1.5 deg of visual angle, and the stimulus onset asynchrony (SOA) between successive dots was 166 msec. The stimulus was presented as a one-shot, not a repetitive cycle; the priming dots were flashed up at time  $t_0$  and were replaced 166 msec later by the north and south dots at time  $t_1$ , and after another 166 msec by the east and west dots at time  $t_2$ . The subject hit key "1" on the keyboard if he saw NE-SW motion along path *j* and key "2" if he saw NW-SE motion along path *k*. It was arranged that hitting key "1" lengthened path *j*, making NE-SW motion less probable, and hitting key "2" shortened path *j*, making NW-SE motion less probable. Paths *i* and *k* were kept constant at 1.5 degrees of visual angle. This negative feedback arrangement controlled a staircase procedure. Each staircase

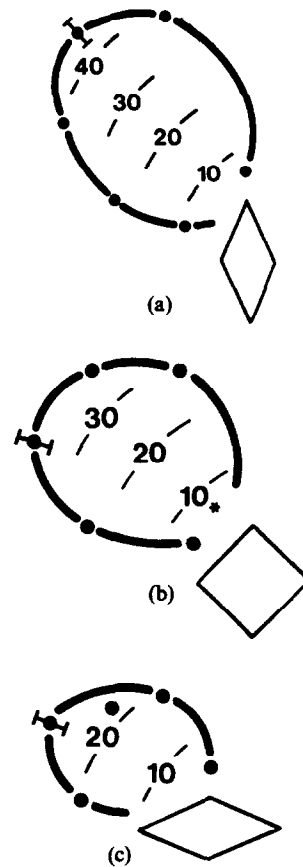

Fig. 3. Results of Experiment 1: angular function of visual inertia. Direction and distance of each datum point from the top corner of the diamond represent a priming angle and the resulting amount of visual inertia, expressed as the percentage difference between the sides *j* and *k* of the diamond. Radial bars represent  $\pm 1$  SE. (a) Narrow diamond: (b) square diamond: (c) wide diamond. The asterisk in (b) shows that *static* priming dots were ineffective, producing only about 7% visual inertia (Experiment 5).

comprised 8 reversals and the average of the last 6 reversals was taken as the path ratio which nulled out the subject's visual inertia. The ratio calculated was  $100 * (j - k) / k$ , which gives the percentage difference between *j* and *k*.

#### Results

The angular functions, or directional tuning curves, of visual inertia are shown in Fig. 3. They form petal-shaped lobes in which the direction of each datum point from the top corner of the diamond represents the priming angle, and the distance from each datum point to the corner represents the amount of visual inertia, expressed as the percentage difference between paths *j* and *k* at the null setting. Percentage markers are shown. Radial bars represent  $\pm 1$  SE. Results have been combined

for priming paths to the left ( $A < 0$ ) and right ( $A > 0$ ) of the vertical. Each datum point is the mean of 30 readings (six 6-reversal staircases  $\times$  five subjects).

In Fig. 3, smooth curves have been fitted by eye to the data points. The lobes for the narrow diamond [Fig. 3(a)] were larger and oriented more toward the vertical than for the wide diamond [Fig. 3(c)]. The lobes for the medium diamond [Fig. 3(b)] were intermediate in shape and size. The overall mean visual inertias for the narrow: square: wide rectangles were in the ratios 1.63:1.45:1. In each case the half-amplitude half-bandwidth of these directional tuning curves was about  $45^\circ$ . The lobes were not symmetrical about the axis which is aligned with the sides of the diamond, but were skewed anticlockwise from this orientation. We attribute this skewing to interactions from the competing lobe (not shown in Fig. 3, but positioned to the right of the diamond) which favours the rival direction of AM. For instance, a lobe cannot extend to the right of vertical, since any priming path to the right of vertical will reinforce path *j* instead of path *k*. Thus the curve may represent an "excitatory" inertia effect, minus an "inhibitory" competition from the other lobe.

## EXPERIMENT 2

### *Interocular Transfer of Visual Inertia: Monocular vs Dichoptic Priming*

In order to investigate the neural site of visual inertia we presented the priming dots to one eye, and the quartet of test dots to the other eye. In the control condition all dots were presented monocularly to the same eye.

The same eleven priming angles were used, together with the medium (square) diamond. Conditions were the same as in the previous experiment except that two copies of the stimulus were presented side by side on the t.v. screen, one for each eye, and fused binocularly by free fusion. Three subjects, who were practised at free fusion, were used. To aid fusion, the left and right eye's stimuli were each surrounded by an outline frame which was  $5.6^\circ$  wide and  $6.2^\circ$  high.

Four separate staircases were each presented twice to each subject, in a randomized order. The conditions for the staircases were:

Condition	Priming dots	Test dots
1.	Left eye	Left eye
2.	Right eye	Right eye
3.	Left eye	Right eye
4.	Right eye	Left eye

### Results

Qualitative: the subjects reported that the monocular and dichoptic conditions looked similar. The apparent motion looked equally convincing, and it was not obvious upon casual inspection whether a given trial was monocular or dichoptic. This is consistent with the finding of Shipley, Kenney and King (1945) and of Ammons and Weitz (1951) that AM can be elicited by flashing one dot to one eye and a displaced dot to the other. These authors did find, however, that dichoptic AM was somewhat less salient than monocular AM.

Quantitative results are shown in Fig. 4. The results for the monocular conditions 1 and 2 were averaged together, and so were the results for the dichoptic conditions 3 and 4. Also the results for left and right priming paths have been combined. Thus each datum point in Fig. 4 is the mean of 24 readings (eight 6-reversal staircases  $\times$  three subjects). In Fig. 4 the overall mean of the dichoptic inertia was 74% of the overall mean monocular inertia. Thus, visual inertia was about three quarters as strong when the priming and test dots were presented to different eyes as when they were presented to the same eye. This high degree of interocular transfer suggests that the site of visual inertia lies at least partly in the binocular pathways, central to the point of binocular fusion.

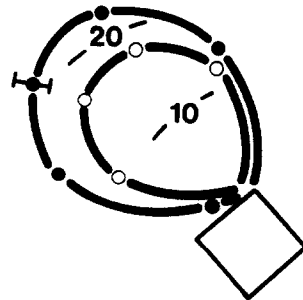

Fig. 4. Results of Experiment 2: monocular vs dichoptic visual inertia. Same conventions as Fig. 3. ● = monocular (priming and test dots presented to the same eye), ○ = dichoptic (priming dots presented to one eye, test dots to the other eye). Dichoptic priming gave 74% as much inertia as monocular priming did, suggesting that inertia lies central to the point of binocular fusion.

## EXPERIMENT 3

*Visual Inertia is Independent of Priming Path Length*

Experiment 1 showed that visual inertia was strongly influenced by the priming angle. The next two experiments show that at the optimum priming angle inertia was relatively independent of the length and duration of the priming path. Since the spatial and temporal intervals determine the effective velocity of the priming stimulus, this suggests that visual inertia may be relatively independent of priming velocity.

In Experiment 3 the priming paths were always at  $+45^\circ$  or  $-45^\circ$ , aligned with the edges of the medium diamond as in Fig. 1(c), (d), but the length  $l$  of the priming path was varied. The sides of the diamond were initially always 1.5 deg of visual angle, but the distance from the priming dot to the first test dot was varied in logarithmic steps over a range comprising 0.075, 0.15, 0.3, 0.6, 1.2, 2.4 and 4.8° (=4.5–288 min arc). The duration of each frame was kept at 166 msec, as before. Six staircases were run on each subject, three with a priming angle of  $+45^\circ$  as in Fig. 1(c), and three with a priming angle of  $-45^\circ$  as in Fig. 1(d). Three subjects were run, using binocular viewing.

Results are shown in Fig. 5. Figure 5 shows that visual inertia was in the range of 20–30%, but it was almost independent of the length of the priming path: the subject's null settings varied by a factor of less than 1.3 over a sixty-four-fold range of priming path lengths.

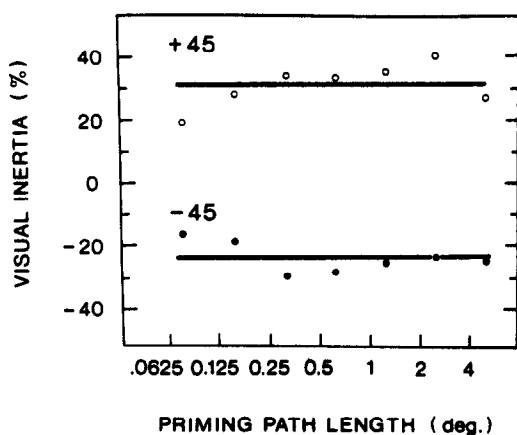

Fig. 5. Results of Experiment 3: visual inertia is independent of the length of the priming path. Abscissa: path length, i.e. separation between priming dot and first test dot. Scale is logarithmic. Ordinate: visual inertia, expressed as the percentage difference between motion paths  $j$  and  $k$ .

This is in marked contrast to the strong effect of the priming angle.

## EXPERIMENT 4

*Visual Inertia as a Function of the Timing of Priming Dots*

As before, the priming dots were always aligned with the edges of the medium diamond, as in Fig. 1(c), (d), and the priming path was now kept the same length as the sides of the diamond (1.5 deg). The timing of the priming dots was varied. The priming and test dots were exposed for durations of 166 msec, as before, but now a dark interstimulus interval (ISI) was introduced between the priming dot and the first test dot. On different trials the ISI lasted for 33, 67, 125, 250, 500 or 1000 msec. The same staircase procedure was used to null out the visual inertia.

Results are shown in Fig. 6. Visual inertia was in the range of 15–20% for short ISIs but fell off steadily with increasing ISI and levelled off at 10% for ISIs of half a second or longer.

Experiment 3 showed that visual inertia was largely unaffected by the spacing of the priming dots. Experiment 4 showed that it fell off as the ISI was increased from 33 msec to 1 sec. Taken together, these results imply that visual inertia is rather insensitive to the equivalent velocity of the priming AM.

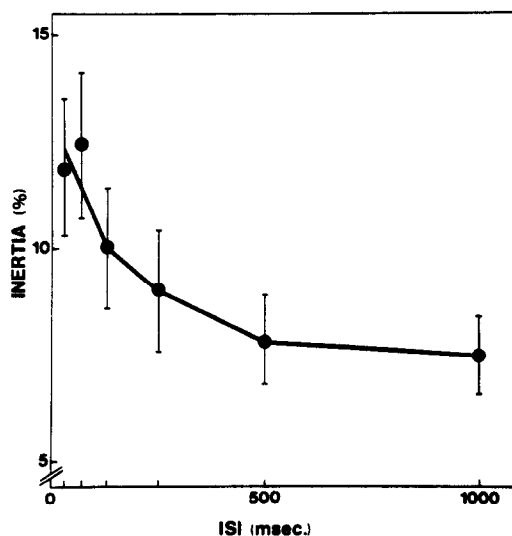

Fig. 6. Results of Experiment 4: visual inertia as a function of the timing of the priming dots (mean of 2 subjects  $\times$  12 staircases). Bars show  $\pm 1$  SE. Inertia was greatest (12%) for short ISIs between the priming dot and the first test dot, falling to 7% for ISIs exceeding 0.5 sec.

## EXPERIMENT 5

*Control Condition: No Inertia From Static Priming Dots*

The conditions were the same as for Experiment 4, except that now the priming dots were static and always visible. Three subjects took part. The priming dots were positioned at either  $+45^\circ$ , as in Fig. 1(c), or at  $-45^\circ$ , as in Fig. 1(d). Results: there was virtually no sign of visual inertia. The null setting (mean of 12 settings  $\times$  three subjects) was 7%. This setting, which is shown as an asterisk in Fig. 3, was only about one-fifth of the visual inertia obtained with dynamic priming dots (Fig. 3). This shows that visual inertia was not merely a Gestalt-like Einstellung or tendency to see static dots as apparently lying in a straight line. Instead it was truly a dynamic effect.

Inertia does not seem to be a Gestalt-like expectation (set or Einstellung). Following a suggestion from J. Pomerantz (personal communication), several frames of priming dots were presented before the test dots. These priming dots were not collinear but were arranged in a zigzag trajectory. This should induce an expectation that the test dot should change direction rather than maintain the last direction from the prime sequence. To test this hypothesis, a number of priming dots ranging from 2 to 16

were arranged in a zigzag and exposed in sequence. Each frame duration was 125 msec and the separation between neighbouring dots was  $1.5^\circ$ . Zigzagging of the test dots was never seen. Instead, the test dots moved in a direction collinear with the *last* pair of priming dots, and all the earlier dots were ineffective. Thus we found no evidence that inertia is an Einstellung phenomenon.

## EXPERIMENT 6

*Two Priming Dots can Trigger an Array of Quartets*

Ramachandran and Anstis (1983a) presented a spatial array of multiple dot quartets simultaneously and found that they all oscillated in the same direction; all horizontally, or all vertically. We now find that priming one central quartet could determine the AM of not only that quartet but of a whole array of quartets.

Nine quartets, arranged in a  $3 \times 3$  array, were presented simultaneously (Fig. 7). A central fixation cross was provided. The side of each square array was  $1.2^\circ$ , and the SOA between successive frames was 560 msec. The central quartet was primed by a pair of priming dots aligned with either the horizontal ( $A = -90^\circ$ ) or vertical ( $A = 0^\circ$ ) sides of the square. Fifty

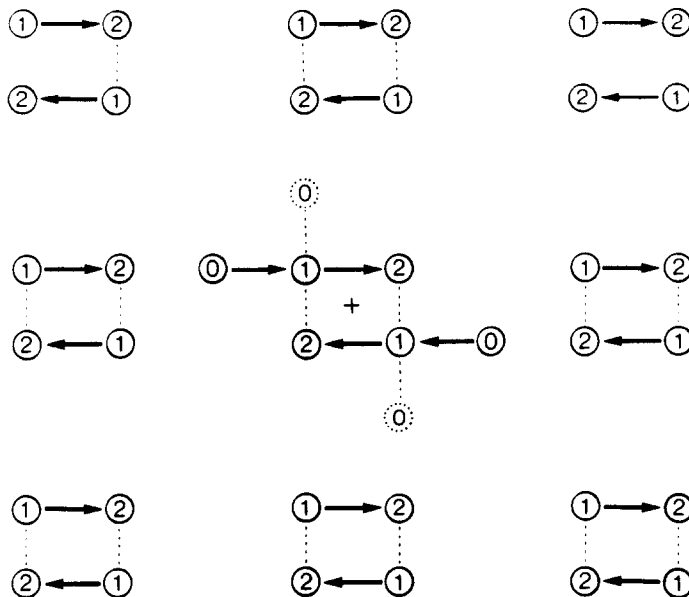

Fig. 7. Stimulus for Experiment 6: nine quartets were presented simultaneously. When the central quartet was primed horizontally, as shown, all the quartets oscillated horizontally (solid arrows). If the central quartet was primed vertically (dotted symbols), all the quartets would oscillate vertically.

consecutive trials were run and  $A$  was randomly set to 0 or  $-90^\circ$  on each trial. The subject hit one of two keys immediately after each trial to indicate whether he saw horizontal or vertical AM. It was found that all nine quartets oscillated in the same direction, and furthermore the direction was determined in most cases by the priming direction. For three subjects the percentage of trials in which the AM was in the same direction as the priming was 100, 60 and 100%. Thus the position of two priming dots determined the AM of eighteen subsequently exposed test dots. Presumably the two priming dots influence the eight surrounding quartets not directly, but in two stages; the priming dots exercise a spatial constraint, acting over time, on the selection of the spatial path of the central quartet, which in turn exercises a spatial constraint on the surrounding quartets.

#### EXPERIMENT 7

##### *Visual Angular Momentum in Rotary Apparent Motion*

Visual inertia is not specific to the four-dot display used in Experiment 1, but can be generalized to other motion patterns. Figure 8(b) and (c) show a cross (+) with vertical and horizontal arms which is abruptly replaced by a superimposed cross (x) with oblique arms. As one might expect, rotary apparent motion is generally seen along the *shorter* rotary path. If the oblique cross is positioned at a clockwise angle of less than  $45^\circ$ , clockwise motion is seen, but if it is positioned at a clockwise angle between 46 and  $89^\circ$ , anticlockwise motion will be seen. For a rotation of  $45^\circ$ , clockwise and anticlockwise AM are equally probable; so we shall call  $45^\circ$  the "equiprobable angle".

In this experiment the vertical cross was preceded by a priming cross [Fig. 8(a)] which was flashed up at a priming angle of (say)  $-20^\circ$  anticlockwise from vertical, then replaced by the vertical cross [Fig. 8(b)], then replaced by the oblique cross at  $+45^\circ$  [Fig. 8(c)]. These three movie frames gave two successive AMs. The AM from the priming to the vertical cross (the "priming AM") was always seen clockwise, as one would expect. Moreover, we found that the AM from the vertical to the oblique cross (the "test AM"), which would normally be ambiguous, was now always seen as clockwise, in the same direction as the priming AM. Since this visual inertia applies to rotary motion, we call

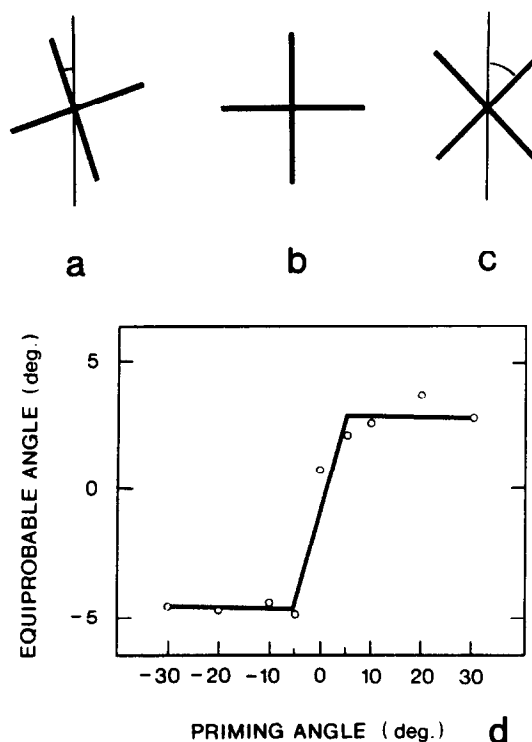

Fig. 8. Visual angular momentum. (a) Priming cross at a priming angle of  $-20^\circ$ . (b) Vertical cross. (c) Oblique cross at a test angle of  $+45^\circ$ . Crosses actually had their centres superimposed and were presented successively, not displayed side by side. When the sequence (b)-(c) was flashed, the test AM was equally likely to go clockwise or anticlockwise. But when the sequence (a)-(b)-(c) was flashed, both the priming AM (a)-(b) and the test AM (b)-(c) were always seen as clockwise. (d) Results. Following an (anti)clockwise priming AM, the test AM was more likely to be (anti)clockwise and the equiprobable angle was shifted (anti)clockwise by 3-4°. The shift was constant for all priming angles from 5 to  $30^\circ$ .

it visual angular momentum. In addition the equiprobable angle was shifted clockwise by several degrees, say to  $48^\circ$ . We used this 3° shift in the equiprobable angle as our measure of visual angular momentum.

Visual angular momentum was measured by essentially the same technique as before. The priming angle was preset to a value of  $-30$ ,  $-20$ ,  $-10$ ,  $-5$ ,  $0$ ,  $+5$ ,  $+10$ ,  $+20$  or  $+30^\circ$  relative to the vertical cross. (Negative numbers indicate an anticlockwise displacement from vertical, positive numbers clockwise.) The oblique cross was initially displaced clockwise from the vertical by a random angle between  $+40$  and  $+50^\circ$ . The diameter of each cross subtended 9 deg of visual angle. The priming cross and vertical cross were each exposed for 117 msec and the oblique cross for 166 msec. On each trial three crosses were flashed up in the

sequence: priming cross—vertical cross—oblique cross [Fig. 8(a–c)]. As expected, subjects reported seeing two apparent motions in quick succession. They were instructed to ignore the first, priming AM (from the priming to the vertical cross), and report only the second, test AM (from the vertical to the oblique cross). They were told that the two AMs might be in the same or opposite directions.

If the test AM looked anticlockwise, they were instructed to hit one key, which was programmed to shift the oblique cross  $2^\circ$  anticlockwise so as to reduce their chances of seeing anticlockwise motion on the next trial. Similarly if the test AM looked clockwise they hit another key, which had the opposite effect. This negative feedback arrangement generated a staircase which automatically homed in on the equiprobable angle for the oblique cross. Each staircase comprised 8 reversals, of which the last 6 were averaged to give the equiprobable angle.

### Results

Results are shown in Fig. 8(d). Each datum point is the mean of nine readings (three 6-reversal staircases  $\times$  three subjects). Figure 8(d) shows that the test motion tended to be in the same direction as the priming motion, and that the equiprobable angle was shifted about  $3^\circ$  in the same direction. It was the direction of the priming motion, not its amplitude, that was important; the shift in the equiprobable angle was about the same whether the priming rotation was through  $5^\circ$  or through  $30^\circ$ .

Notice that since the apparent motion was rotary, instead of linear as in Experiments 1–4, the priming angle in the present experiment should be compared *not* to the priming angle but to the priming path length in Experiment 3. Experiments 3 and 7 both show that visual inertia was insensitive to the amplitude of the priming motion.

### DISCUSSION

It is unlikely that visual inertia arises from tracking eye movements. Although several of our subjects were unaware of the purpose of our experiments they were practised observers who were instructed to fixate carefully. As a control to rule out eye movements we showed our subjects two copies of the rotary stimulus of Fig. 8(a), (b) and (c). The two copies were presented side by side with a fixation point centred between them. The oblique cross was at  $45^\circ$  to the

vertical cross, so it would normally give ambiguous AM unless biased by visual angular momentum from the priming cross. We found that when the two stimuli were identical (both priming crosses at  $-20^\circ$ ) they were both biased clockwise and both appeared to rotate clockwise, but when they were mirror images (one priming cross at  $-20^\circ$  and the other at  $+20^\circ$ ) they were biased in opposite directions and appeared to rotate in opposite directions. No pattern of eye movements could produce such opposite rotations.

Our main finding is that in an ambiguous AM display the test AM tended to be perceived in the same direction as the priming AM. This was true whether the competing test AMs were along straight lines in directions differing by  $45^\circ$ ,  $90^\circ$  or  $135^\circ$ , as in Experiments 1–3, or were rotations in opposite directions, as in Experiment 6. Visual inertia refers to this tendency for the direction of the priming AM to carry over and determine the direction of the ambiguous test AM.

We found in Experiment 1 that visual inertia falls off when AM changes its direction—the curved paths of swerving objects are systematically discounted by the motion sensing system. Its orientational tuning curve has a half-bandwidth of about  $45^\circ$ , so the directional response is graded. However, the response to the apparent velocity of priming AM is all-or-none; visual inertia is highly sensitive to the direction of priming motion, less so to its timing (Experiment 4) and quite insensitive to its amplitude (Experiments 3 and 7). Since the equivalent velocity of AM depends on its timing and amplitude, these results imply that visual inertia is fairly insensitive to the apparent speed of priming AM. The equivalent velocity of AM is a thorny problem (Kolars, 1972) and is perhaps too difficult for the visual system to solve; it might make sense to ignore it in favour of a simple robust rule that objects usually keep moving in the same direction. Visual inertia is unaffected by the equivalent velocity of priming motion, and seems to be a simple triggering or sequencing mechanism which responds to temporal ordering and to spatial direction, but not to velocity.

Inertia is clearly not the only factor influencing perceived direction. An ambiguous quartet of dots will show spontaneous reversals, first moving vertically, then horizontally, then clockwise, and so on. In the same way, the repeated alternations of a + and an  $\times$  super-



imposed center to center (without a priming cross) leads to several possible motion percepts. One can see oscillation back and forth; or sometime rigid rotation sustained in a clockwise or anticlockwise direction for a prolonged period. This would fit in with the idea of inertia, and also with the proposal in Experiment 6 that motion paths tend to be integrated in a consistent fashion across the visual field. At other times one may see a disorganised flapping motion, in which each spoke of the cross seems to move at random from frame to frame, independently of the others (Kolers and Pomerantz, 1971). In addition, even the rigid percept can be sustained only so long before a spontaneous reversal occurs. This changeability shows that inertia is not the whole story, otherwise one would never find spontaneous reversals. Reversals are not usually rapid; once motion is perceived in a particular direction, say horizontal motion among four dots arranged in a square, that percept tends to resist change, so that horizontal motion persists even when the vertical separation between the dots is reduced. This hysteresis, which is typical of co-operative systems, has been extensively studied by Eggleston (1984).

We believe that visual inertia is no mere curiosity but plays an important role in parsing motion. The primary task in motion perception is to detect correspondence, that is, identify successive parts of the visual scene as representing a single object in motion (Anstis, 1970; Ullman, 1979). Ullman has shown that the visual system solves the correspondence problem by provisionally pairing off items on the basis of proximity and similarity. A final selection between alternative possible pairings is then made by competitive local interactions to find the correspondences with lowest cost function. We now propose a new temporal constraint; the costing of alternatives is constrained by motions seen in the immediate past—the previous correspondences influence the selection of new ones. Motion just seen helps to determine what motion will be seen next. This is shown by the ability of our priming spots at time  $t_0$  to counter the effects of proximity in our test spots at times  $t_1, t_2$ . Therefore when assigning correspondences in AM the visual system is able to examine at least *three* successive time frames, and in deciding which candidates to link up it will favour items whose three successive positions lie along, or near, a straight line. In the competitive local interactions between potential

linkages, visual inertia bestows on a candidate sequence a decided competitive edge. Thus visual inertia helps to solve the correspondence problem.

There are two distinct though related possibilities here: (a) correspondences are selected over three or more frames considered together; (b) the motion derived from correspondences detected in a pair of frames at times  $t_0, t_1$  could influence the correspondence process between frames at  $t_1, t_2$ . We attempted to test (a) in pilot work by looking for visual inertia acting apparently “backwards in time”, but the observations were hard to make and we did not obtain clear results. We cannot yet rule out either hypothesis.

Inertia might operate at either a low or a high level in the visual system. When the priming dots are aligned with, say, the vertical sides of a square of dots, the vertical motion of three dots competes against the horizontal motion of only two dots. A sequence of three dots contains more energy along the direction of motion than a sequence of two dots (Sperling *et al.*, 1985), and presumably stimulates the sub-units of a neural motion detector more strongly, so the stronger sensory stimulus would win the day. On the other hand, one could argue that correct correspondences are established by a post-coding decision process, since in principle any item in one time frame can be paired off with any other item in the next time frame that happens to be nearby or similar, leading to a multiplicity of false pairings. Fortunately the number of false pairings is greatly reduced by our living in a non-random world in which objects have predictable redundancies which impose constraints on the number of legal matches that “make sense” (Ramachandran and Anstis, 1983b). A moving physical object cannot change or reverse its course instantaneously, so if you know where something came from you can often tell where it is going. The visual system may exploit the recent history of a target in order to predict its future position. This probably lies directly ahead of its present trajectory, or, less probably, slightly off to one side. Thus the visual system translates informational redundancies such as inertia into specific rules (Marr, 1982). Visual inertia may embody a prediction by the visual system that objects tend to move in a constant direction, as illustrated by Newton’s first Law of Motion. Think of items in movie frames as sensory datum points; then apparent motion is a hypothesis to be supported by the best curve

that the visual system can fit to these points on a dynamic graph. It is a truism that two points provide very weak evidence to support a line on a graph, but extrapolation from two points suggests where a third future point should lie, and if it subsequently appears there the perceptual hypothesis of apparent motion is thereby confirmed. Further research is needed to show over how many movie frames, or over how long an integrating time, the visual system can amass evidence that points toward the best solution to the correspondence problem.

*Acknowledgements*—S.M.A. was supported by Grant A-0260 from the Natural Sciences and Engineering Research Council of Canada, and V.S.R. by Grant 89236-1 from the Sloan Foundation. We thank Deborah Giaschi for assistance in collecting the data.

#### REFERENCES

- Ammons C. H. and Weitz J. (1951) Central and peripheral factors in the phi phenomenon. *J. exp. Psychol.* **42**, 327–332.
- Anstis S. M. (1970) Phi movement as a subtraction process. *Vision Res.* **10**, 1411–1430.
- Eggleston R. G. (1984) Apparent motion and prior correspondence effects in visual perception. *Diss. Abstr. Int.* **44**, 2581–2582.
- Gengerelli J. A. (1948) Apparent movement in relation to homogeneous and heterogeneous stimulations of the cerebral hemispheres. *J. exp. Psychol.* **38**, 592–599.
- Kolers P. A. (1972) *Aspects of Motion Perception*. Pergamon Press, Oxford.
- Kolers P. A. and Pomerantz J. (1971) Figural change in apparent motion. *J. exp. Psychol.* **87**, 99–108.
- Marr D. (1982) *Vision*. Freeman, San Francisco, Calif.
- Mather G. and Anstis S. M. (in press) Motion perception: second thoughts on the correspondence problem. In *Proc. SIGGRAPH Conf. on Motion*, Toronto, 1983 (Edited by Tsotos J.). Elsevier, Amsterdam.
- Ramachandran V. S. and Anstis S. M. (1983a) Perceptual organization in moving displays. *Nature, Lond.* **304**, 829–831.
- Ramachandran V. S. and Anstis S. M. (1983b) Extrapolation of motion path in human visual perception. *Vision Res.* **23**, 83–85.
- Sperling G., van Santen J. P. H. and Burt P. (1985) Three theories of stroboscopic motion detection. *Spatial Vision* **1**, 47–56.
- Shiple W. C., Kenney F. A. and King M. E. (1945) Beta apparent movement under binocular, monocular, and interocular stimulation. *Am. J. Psychol.* **58**, 545–549.
- Ullman S. (1979) *The Interpretation of Visual Motion*. MIT Press, Cambridge, Mass.